

0 601 801 003

Stand | 07-99
Issue | 13-12-03

Fig./Abb. 1

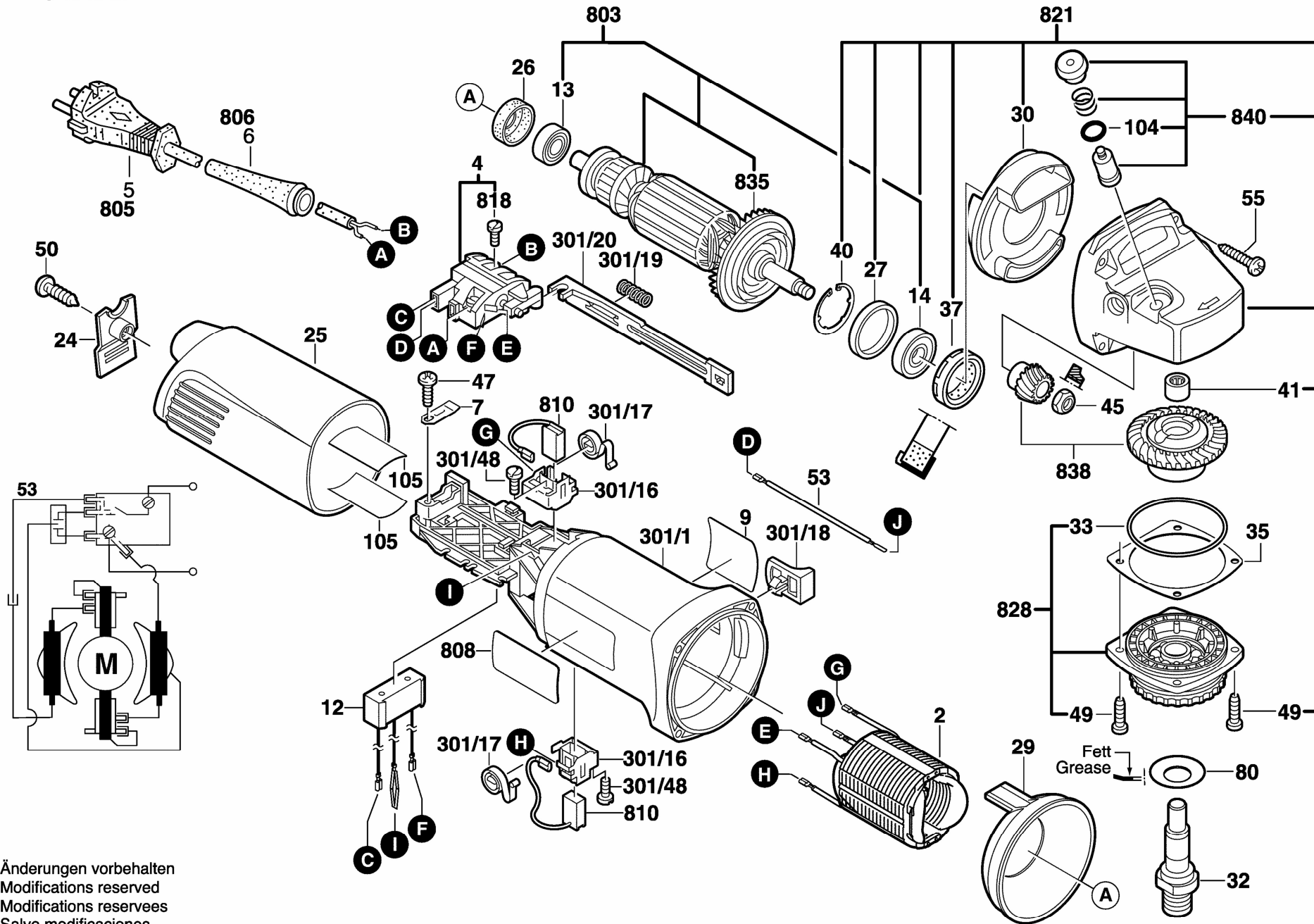

Änderungen vorbehalten
Modifications reserved
Modifications reserves
Salvo modificaciones