

0 601 372 003
Stand 11-07
Issue 13-08-28

Fig. /Abb. 1

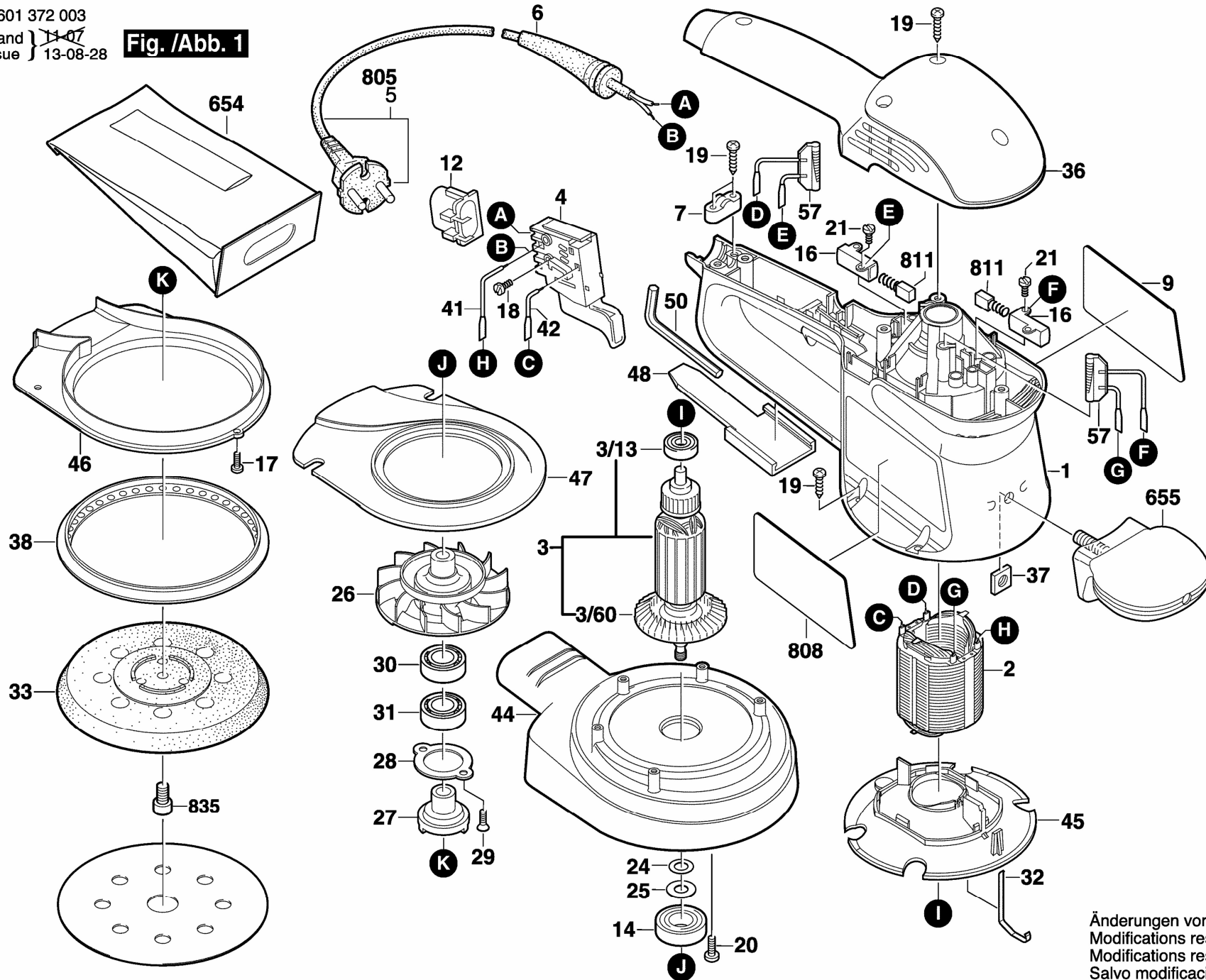

Änderungen vorbehalten
Modifications reserved
Modificaciones reservées
Salvo modificaciones