

3 601 H21 000

Stand } 16-05  
Issue } 21-02-17

**Fig. /Abb. 1**

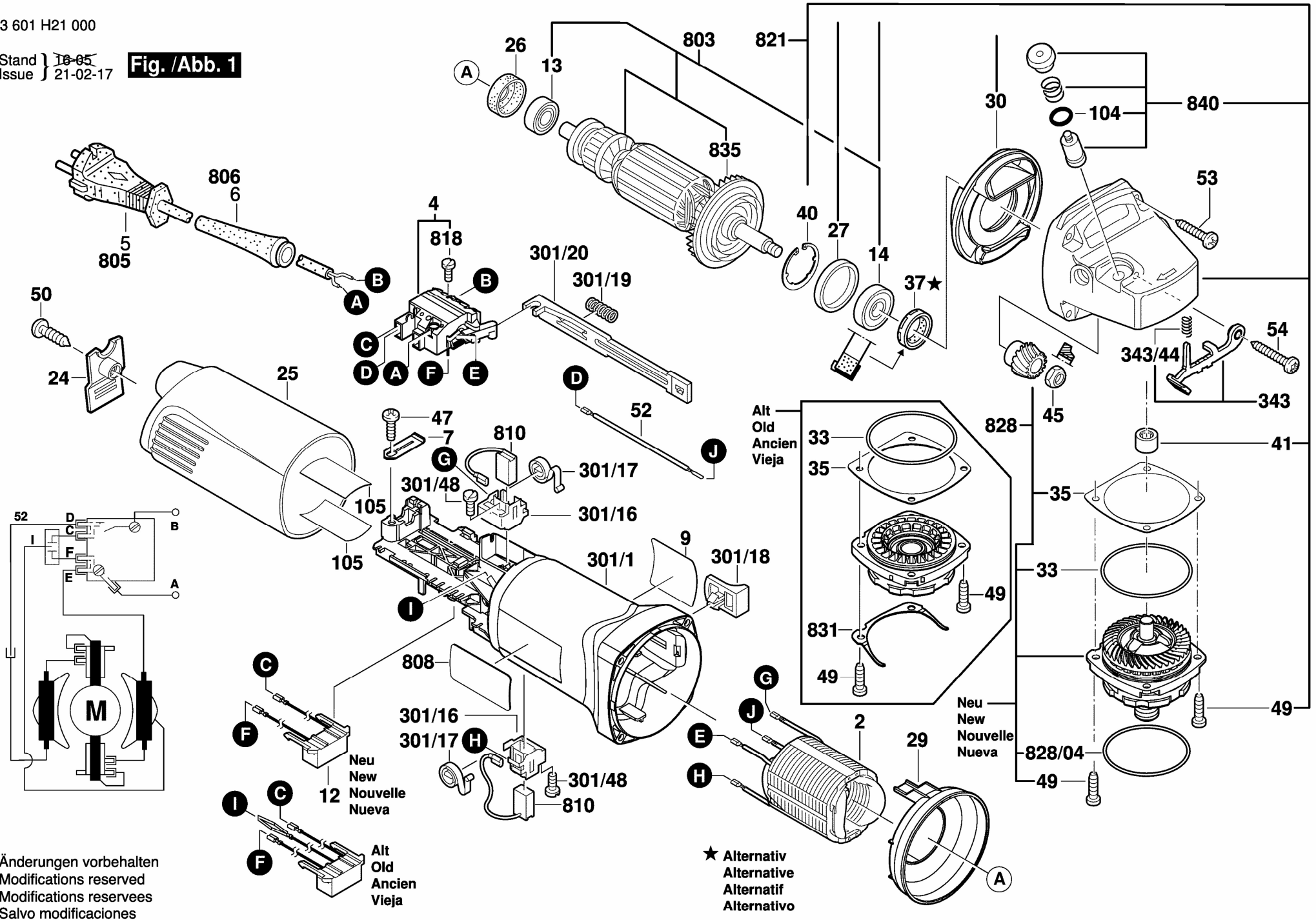

Änderungen vorbehalten  
Modifications reserved  
Modifications reserves  
Salvo modificaciones