

3 601 B20 000
Issue }
Stand } 12-01-30

Fig./Abb. 1

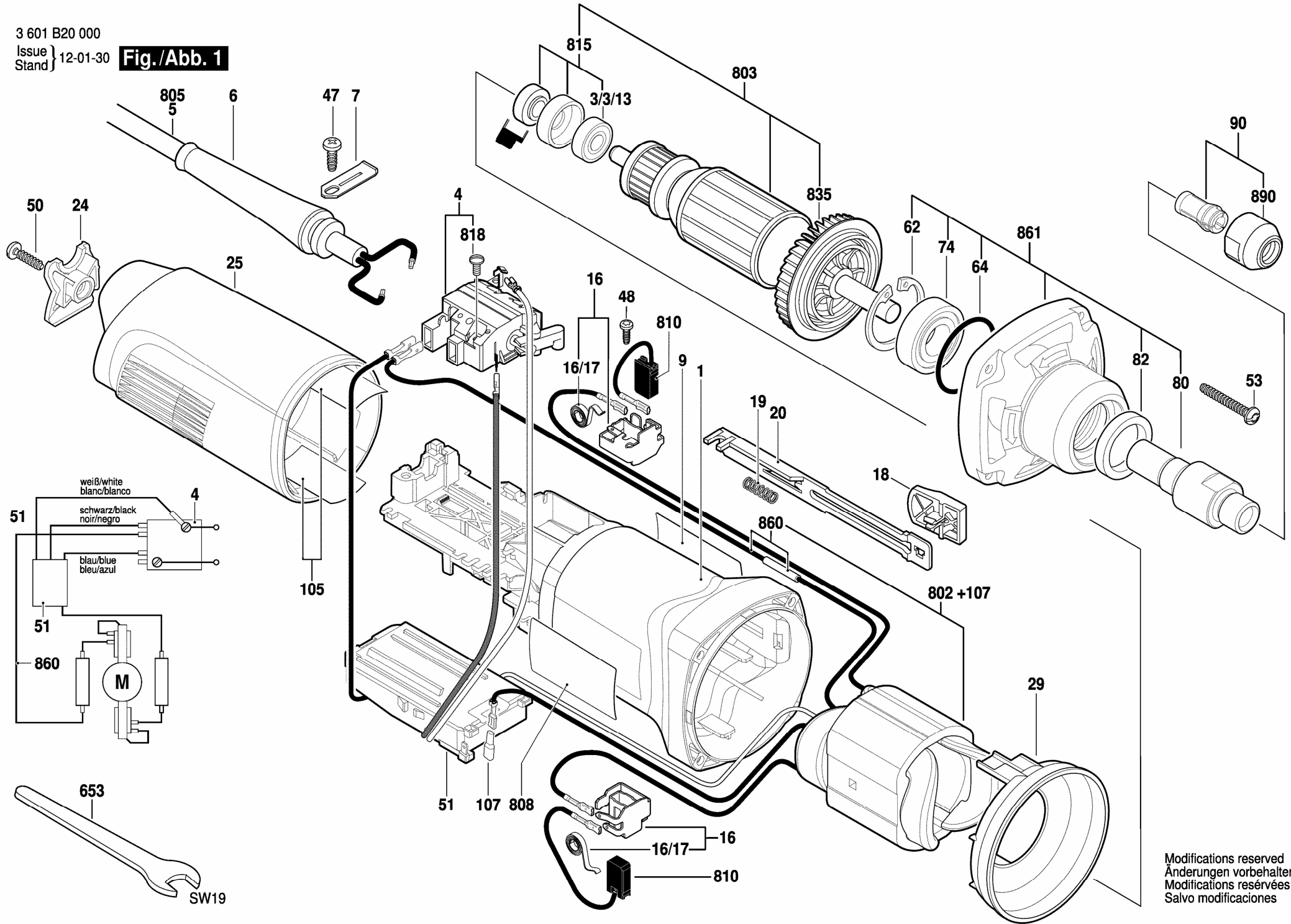

Modifications reserved
Änderungen vorbehalten
Modifications réservées
Salvo modificaciones