

0 601 806 703

Stand | 07-09

Issue | 12-12-12

Fig./Abb. 1

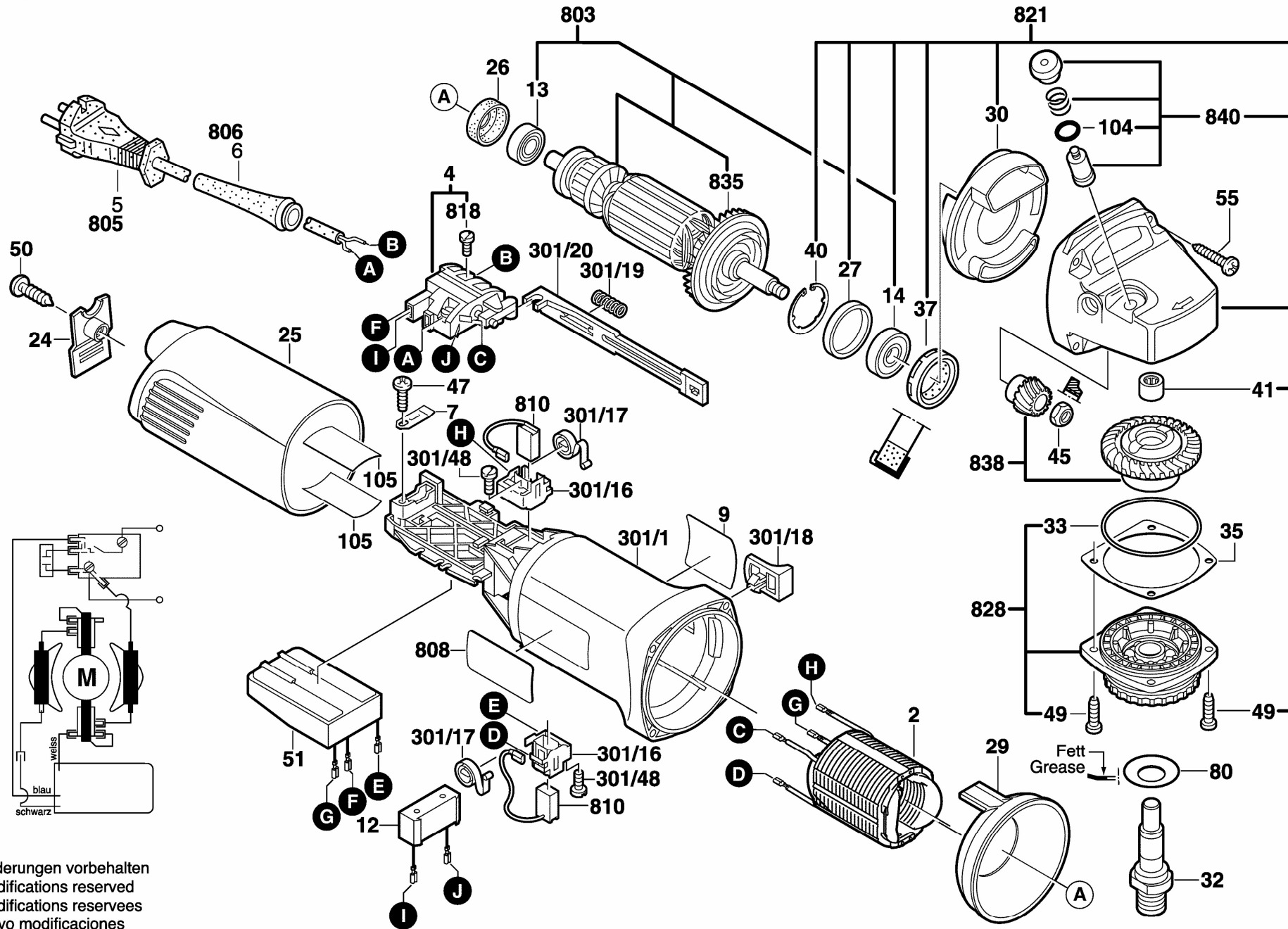

Änderungen vorbehalten
Modifications reserved
Modifications reserves
Salvo modificaciones