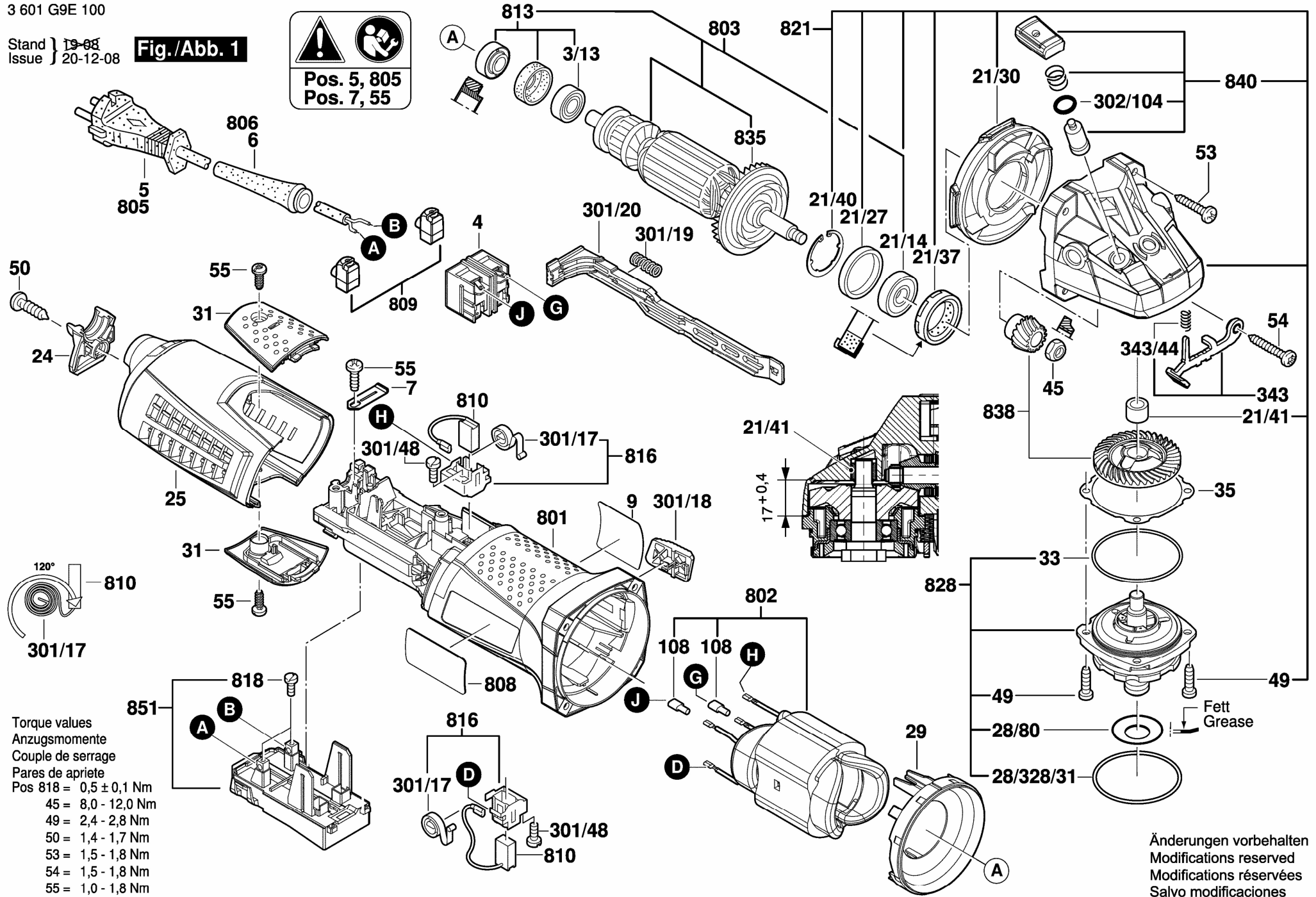

Fig./Abb. 1



- Torque values
Anzugsmomente
Couple de serrage
Pares de apriete
- Pos 818 = $0,5 \pm 0,1$ Nm
45 = 8,0 - 12,0 Nm
49 = 2,4 - 2,8 Nm
50 = 1,4 - 1,7 Nm
53 = 1,5 - 1,8 Nm
54 = 1,5 - 1,8 Nm
55 = 1,0 - 1,8 Nm

Änderungen vorbehalten
Modifications reserved
Modificaciones reservadas
Salvo modificaciones