

HR2651

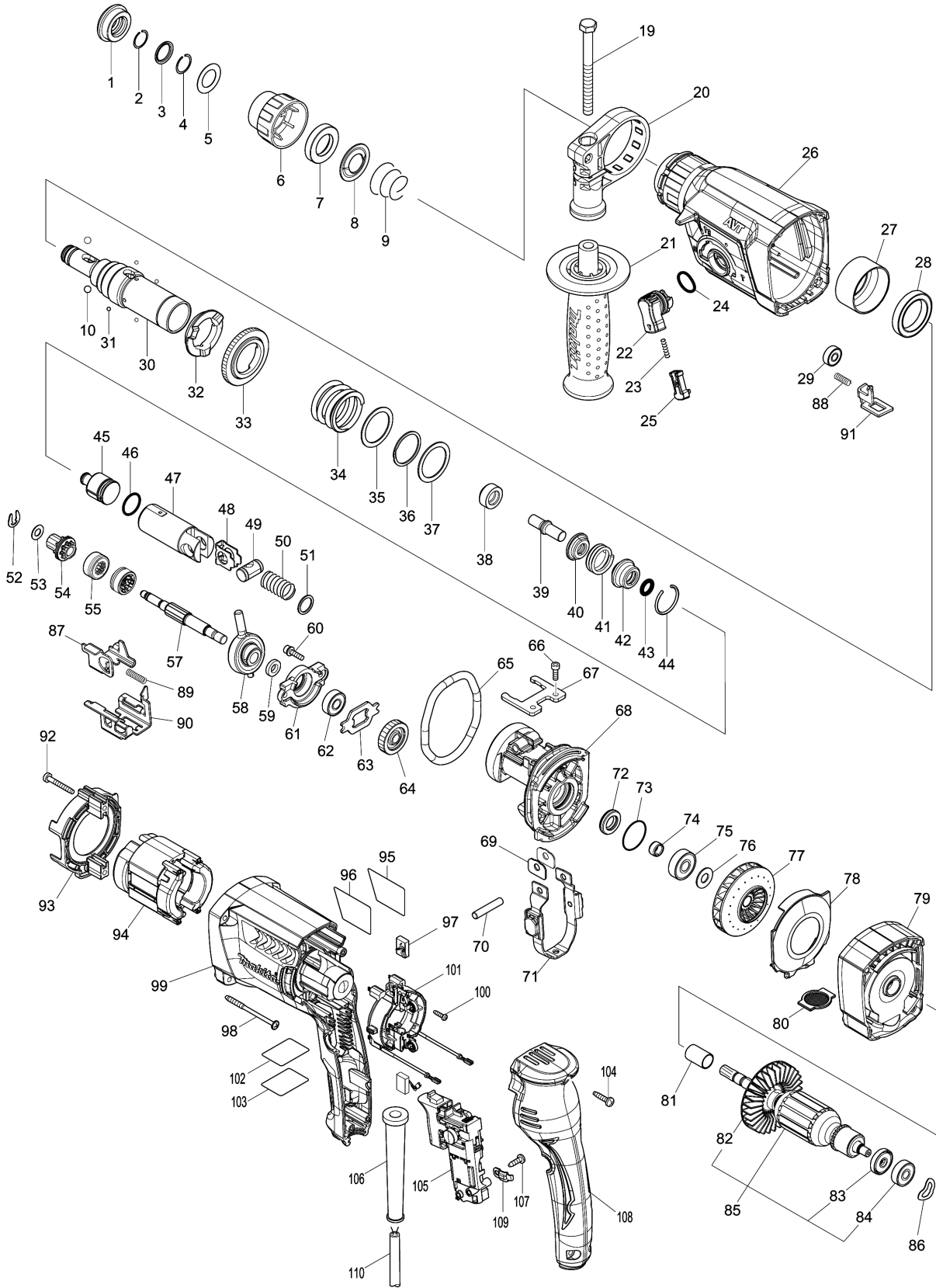

112

